



STEEL DOORS & FRAMES

SERVICE & TECHNOLOGY FOR YOUR SAFETY
SINCE 1973



METAL+ INSIDE



FIRE RESISTANCE



BURGLARY RESISTANCE



BULLET-PROOF



ACOUSTIC PERFORMANCE



ANTI-PANIC

THE METAL+ INSIDE CONCEPT

THE BASIS ON WHICH EVERY HEINEN DOOR IS BUILT



Heinen Doors is a manufacturer of steel and stainless steel doors and frames. Our workshops have been located in Belgium in the heart of Europe since 1947. All our products are designed, developed and produced here. Our range of doors is developed around an exclusive flexible solution: **the Metal+ Inside concept.**

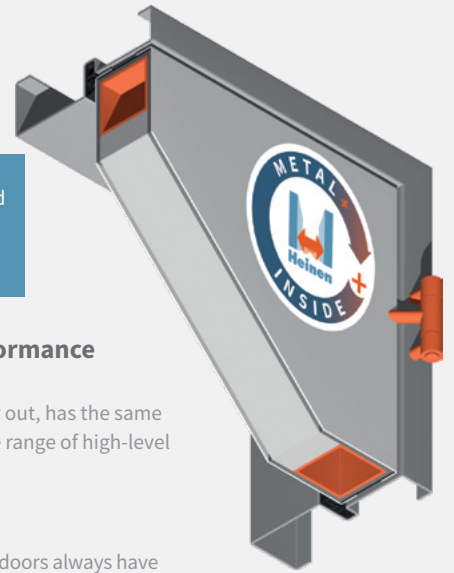

Hinged doors, two-way doors or hatches

Metal+ doors are available in a wide variety of configurations: hinged doors with a mortared or bolted frame, surface-mounted, floor hatch and even two-way doors. The installation method determines the basic and optional performances, as well as the duration of the warranty.

Replacement

The hinges and the metal skin are screwed on, not welded into the internal tubular frame. The maintenance-free hinges are adjustable and replaceable after damage or vandalism. The two cover plates are also separately replaceable.

Modular design: bespoke performance combinations

Each door, whether it is fitted indoors or out, has the same robust tubular structure to which a wide range of high-level performance features can be added.

Finish

Regardless of their performance, Heinen doors always have the same appearance. They can be finished in galvanised steel Magnelis® ZM 250, stainless steel or RAL colour.

Custom-made

All Heinen doors are made to measure. Accessories and locks are chosen according to the end-user's needs. Each door leaf has a unique production number.

THE METAL+ INSIDE SOLUTIONS

Hinged doors

Mortared or bolted frame

- Single or double door/XXL
- Double door without priority
- Right/left double door
- Vertical hatch

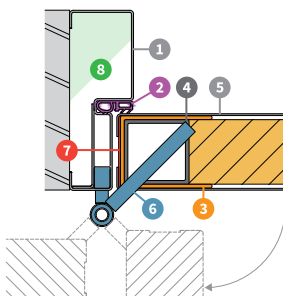

Two-way doors

Mortared frame

- Single or double door

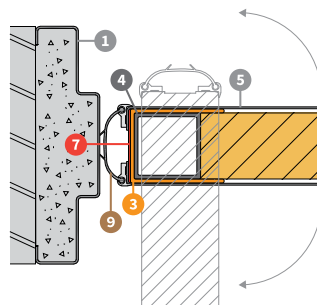

Other solutions

Mortared frame

- Surface mounted hinged door
- Floor hatch
- Fixed glazed/full windows, side and top light

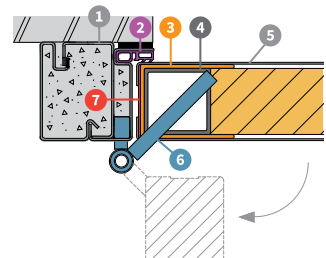

- 1 Frame (steel sheet 15/10 or 20/10) covering the thickness of the reveal for an attractive finish (with optional thermal break).
- 2 Double lip seal.
- 3 Insulation around the edges of the door (with intumescent material for fire doors).
- 4 Tubular steel structure (60 x 60 x 2 mm).
- 5 Door skin comprising 15/10 galvanised steel sheet screwed into the tubular structure and individually replaceable.
- 6 Self-lubricating hinges, adjustable and replaceable, screwed into the tubular door structure.
- 7 Hyper-strong synthetic material (for optimum protection of the insulation or intumescent material incorporated into the door leaf).
- 8 Frame filling depending on installation method.
- 9 Rounded smooth edges.

THE FUTURE-PROOF SOLUTION



Screw-on hinges



Screw-on cover plates



Standard finish: Magnelis® ZM 250 galvanized steel sheets

BASIC PERFORMANCE OF THE METAL+ HINGED DOOR



Frequency of use

Up to 1,000,000 open/close cycles (max. level)
+ durability of automatic closure: 200.000 cycles (C5).



Mechanical resistance

M4 (maximum normative level).
Up to M+7 (maximum level beyond the standards).



Service life of the door

15-year warranty on the door set with mortared frame.
10-year warranty on the door set with bolted frame.

Under certain conditions, Metal+ doors have also :



Burglary resistance

RC2.

With automatic Kältefeind threshold:



Acoustic performance

Basic soundproofing: single door RW = 36dB.



Airtightness

Minimum L2.



Thermal insulation

Value between 1.7 and 1.9 W/m²K (depending on dimensions).



Fire resistance

EI1-20 and EW 45.

FINISHES AND IRONMONGERY

Finishes

- Hot-dip galvanised steel (Magnelis® ZM250)
- Stainless steel (304 & 316)
- RAL painting (optional)

Hardware for interior and exterior doors

- Locks (standard, anti-panic, security, self-locking, etc.)
- Access control and remote surveillance
- Push and pull handles
- Anti-panic devices
- Fire and burglary resistant ventilation louvres
- Door closers
- Weather strip systems
- Thresholds
- Glazing

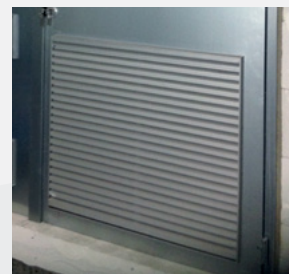
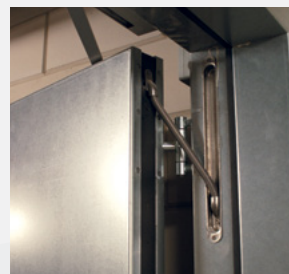

OPTIONAL AND CUMULATIVE PERFORMANCES

PERFORMANCE DETAILS



Below are the performances by door type and installation method. Some performances are only available for full doors without glazing. Most of these performances can be combined up to a certain limit. The absence of a value in this table means that the configuration still needs to be validated. For an overview of combinable performances by door type, consult our technical data sheets via the website or the sales engineers.

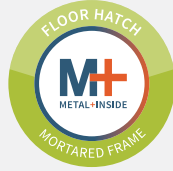
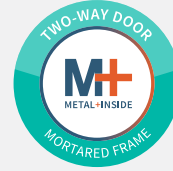

		HINGED DOOR METAL-INSIDE MORTARED FRAME	HINGED DOOR METAL-INSIDE BOLTED FRAME	SURFACE MOUNTED DOOR METAL-INSIDE MORTARED FRAME	TWO-WAY DOOR METAL-INSIDE MORTARED FRAME	FLOOR HATCH METAL-INSIDE MORTARED FRAME
	Fire resistance	EN 1634-1 E1: 30, 60, 120, 180 E2: 30, 60, 120, 180, 240 EW: 30, 60, 120, 180, 240, 300 HCM N2, N3	E1: 30, 60 E2: 30, 60, 120 EW: 30, 60, 120	E1: 30, 60 E2: 30, 60 EW: 30, 60	E1: 30, 60 E2: 30, 60 EW: 30, 60	-
	BENOR	RF30 - RF60	-	RF30 - RF60	RF30 - RF60	RF30 - RF60
	Smoke tightness	EN 1634-3 Sa, Sm (S200)	Sa, Sm (S200)	Sa, Sm (S200)	-	Sa, Sm (S200)
	Burglary resistance	EN 1627-1630 RC2 - RC3 - RC4 - RC5	RC2 - RC3 - RC4	RC2	-	RC2 - RC3 - RC4 - RC5
	Belgian Justice standard	AE 20 P1, P2 Cell door	-	AE 20 P1, P2 Cell door	-	-
	Bullet-proof	EN1522-1523 FB4 - FB5 - FB6 - FB7 AK47	-	-	-	-
	Acoustic performance	EN 717-1 Rw (C ; Ctr) dB (A)	Rw from 36 to 54 dB	-	Upon request	-
	Anti-panic	EN 179 EN 1125	✓	✓	✓	Upon request
	Thermal insulation	EN 10077-1 EN 10077-2	Between 1,5 and 2 W/m²K	Between 1,5 and 2 W/m²K	-	Between 1,5 and 2 W/m²K
	Airtightness	EN 1026 EN 12207	Minimum L2	Minimum L2	Minimum L2	-
	Watertightness	EN 1027 EN 12208	✓	✓	✓	-
	Wind resistance	EN 12211 EN 12210	✓	✓	✓	-
	Electromagnetic shielding	Upon request	✓	✓	✓	-
	Blast-proof	Only static calculations	All requests for explosion protection must be examined on a case-by-case basis. The calculation models used are based on equivalent static calculations.			

SELECTION OF APPLICATIONS

Discover our different door types, from the simplest to the largest (with fire protection certificate), and a multitude of applications.



Cell (police - prison)



Electric cab / Synergrid



Datacenter / IT room



Stainless steel kitchen / Food industry



Parking



XXL



Two-way doors

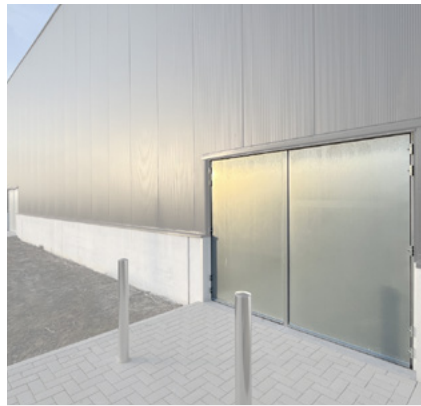

Emergency exit / Exterior

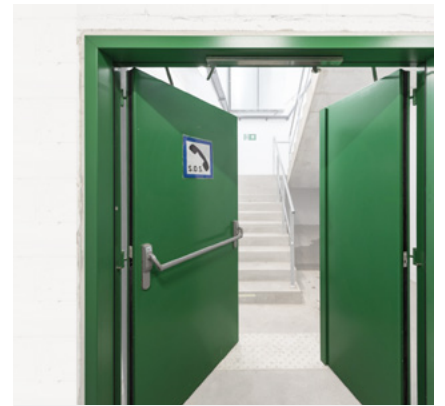

HCM Tunnel



Swimming pool



Floor hatch



Panic exit / Culture



HEINEN DOORS CAN SUPPORT YOU FROM THE VERY BEGINNING SPECIFICATIONS

Are you looking for a professional way of integrating safety into your projects, right from the drawing up of specifications or invitations to tender? Heinen Doors' team of sales engineers will work with you to determine the technical feasibility of your project. We can also put our BIM elements at your disposal.

OUR PARTNERS AND INSTALLERS BY YOUR SIDE

Thanks to a network of certified local partners and installers, we can take care of your projects from the very first request right through to installation, acceptance of work and door maintenance.

For a complete list, visit our website: www.heinen-doors.com



WITH HEINEN DOORS, CONTROL ALL YOUR RISKS!

Our engineers and partners use our H-Config software to help you configure your ideal door and visualize its specific features.

Heinen Doors complies with quality (ISO 9001) and traceability standards for design, orders and production.

We are constantly working with our partners to maintain and, wherever possible, improve our quality standards.

REFERENCES



CULTURE, SPORTS & EDUCATION : Galerie Hufkens (BE) • Musée d'Arnhem (NL) • Palais 12 Heysel (BE) • Théâtre de Poitiers (FR) • Ancienne Belgique (BE) • Gayant Expo (Douai FR) • Arena Stade (Lievin FR) • Le Louvre (FR) • Bibliothèque Nationale de France • Ecole Américaine (BE) • Institut des Arts & Métiers (BE) • KUL (BE) • De Singel • Ecole de Musique (Evry FR) • DISTRIBUTION : Delhaize • LIDL • Aldi • Colruyt • Carrefour • K in Kortrijk (BE) • Ikea • Mediamarkt • Decathlon • Esprit • Cartier (CH, FR) • Nike • Van Marcke • TUNNELS : Tunnel Leopold II (BE) • Tunnel A11 • Tunnel Schuman, Reyers, Cinquantenaire • PARKINGS : Q-Park • Indigo • Interparking • Parking FNAC (Paris FR) • Parking Marboeuf (Paris FR) • Parking P&R Oosterweel • TRANSPORT : SNCB • STIB • Métro de Marseille (FR) • Gare des Guillemins (BE) • Aéroport de Koweït (KW) • Aéroport de Dubai (AE) • SNCF (FR) • SOCIAL/REAL ESTATE : CHU (B, NL, Tahiti) • Kortenbergh • Hôpital Corentin Celton (FR) • Hôpital Ste Anne (FR) • Hôtel Vini Divini (BE) • Doha Palace (QA) • HIGH SECURITY : Ministère de la Justice (BE) • Ministère de la Défense (BE, FR, NL) • OTAN • Conseil de l'Europe (Bruxelles) • Centres pour illégaux (BE) • Ambassade de Belgique • Palais de Justice (Antwerpen, Liège, Gent, Brugge BE) • Ambassade du Canada (PT) • ENERGY : Umicore • Totalfina • Areva Framatome (FR) • CEA (FR) • Engie-Electrabel Doel & Tihange (BE) • Borsele (NL) • Sellafield (GB) • Elia • Fluxys • Gassco • Electrawinds • GRT Gaz (FR) • Sonatrach (DZ) • INDUSTRY : GlaxoSmithkline • Johnson & Johnson • Solvay • Pfizer • Bayer • BASF • 3M • Ajinomoto Omnicem • Dupont de Nemours • Sanofi • Procter & Gamble • Stora Enso • Industrial Acoustics (HK) • Arcelor Mittal • Volvo • Opel • Honda • Audi • PSA Peugeot • Rolls Royce (GB) • FOOD INDUSTRY : Clarebout • Callebaut • AB-Inbev • Mc Cain • Alpro Soja • Teepak • Coca-Cola (FR) • Pepsico • Poco Loco • Agristo • Milcobel • Mydibel • Cargill • Aviko • BANK : Axa • Banque de France • Banque Nationale de Belgique • Deutsche Bank • Bpost • ING • Caixa General de Depósitos (PT) • Crédit Européen (LUX) • MEDIA/TELECOM : France Televisions (FR) • RTBF • RTL GROUP (FR) • Tunesian Television (TN) • Roularta • Proximus • France Telecom (FR) • Orange • Base • Karkh Telecom (Bagdad IQ) • Shanghai Bell (CN)

